

# SNAPTRACK

THE ULTRA-PORTABLE CAMERA SLIDER

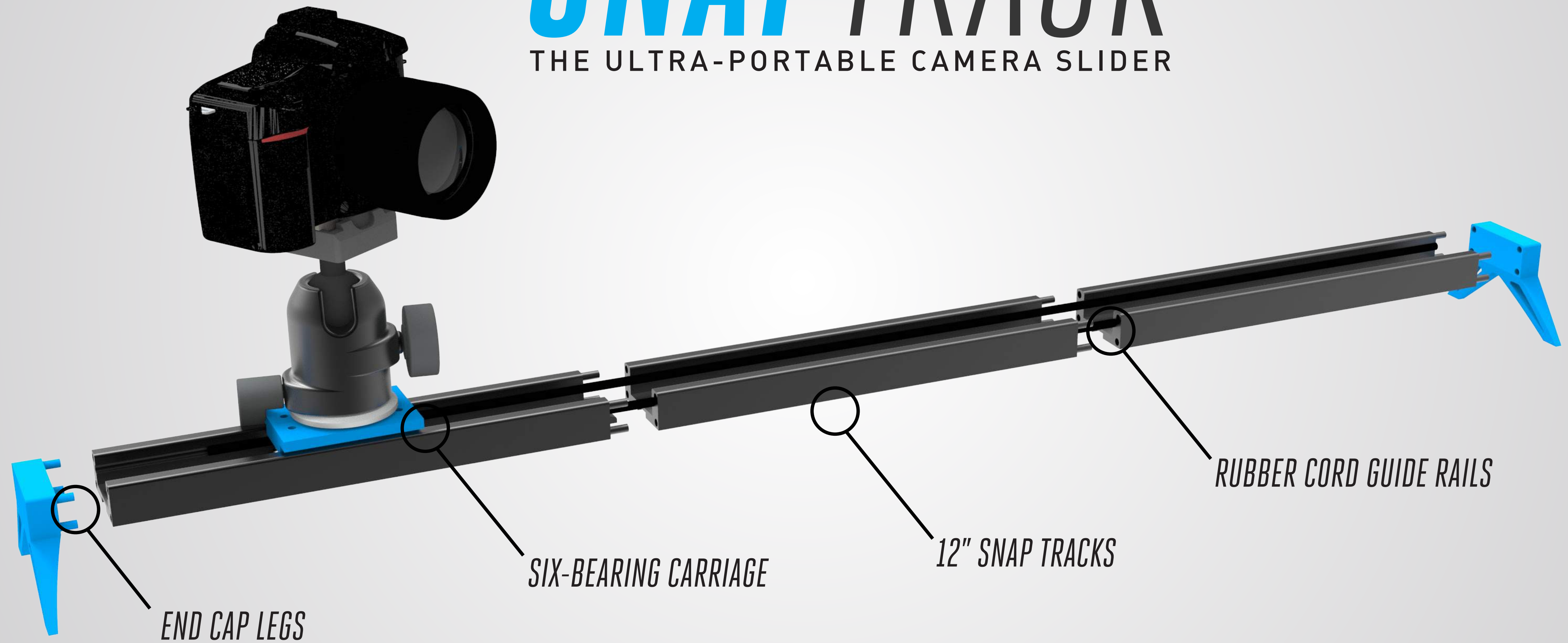

## CAMERA SLIDERS



- necessary tool
- tracking shots
- production value



## WHY CAMERA SLIDERS

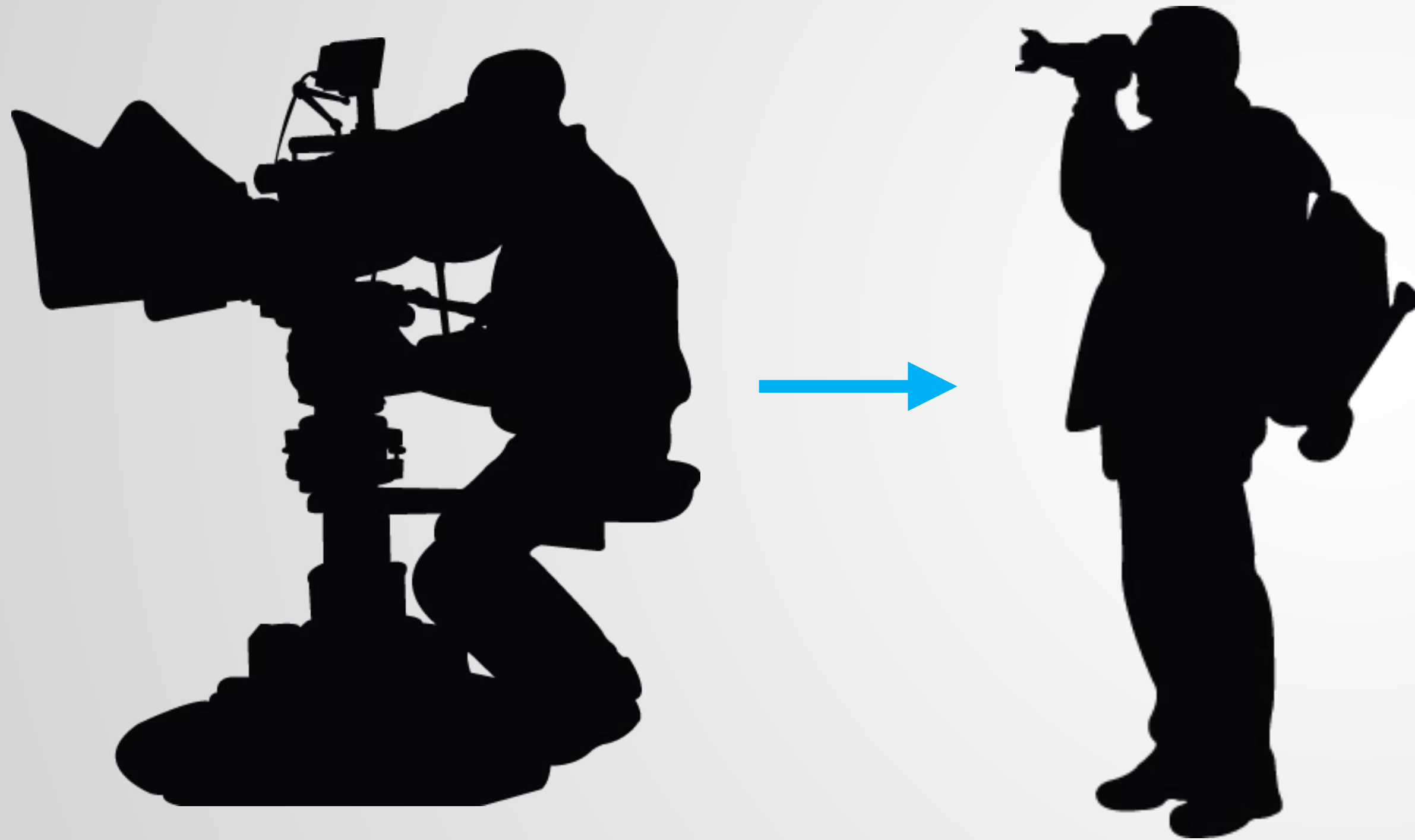

- enthusiast/prosumer
- growing DSLR market
- on-the-go users
- DIY users
- Kickstarter projects

# *THE PROBLEM*

- expensive
- unportable
- heavy
- targeted for professionals
- redundant equipment

## FRICITION-BASED SLIDER

- \$149 for 47.5" track
- light
- unportable
- not reliably smooth





## ROLLER BEARING-BASED SLIDER

- \$100 - 32" track
- light
- smooth
- **unportable**



## AIRTRACKS

- \$250 - 60" track
- ultra-portable
- expensive
- not professional
- not mountable





## SLIDER PLUS

- \$500 - 16" track
- compact
- smooth
- expensive





## *CUSTOMER NEEDS*

- light
- ultra-portable
- smooth
- inexpensive

# THE SOLUTION



- modular
- continuous
- expandable
- mountable
- light
- inexpensive



*THE SOLUTION*

# **SNAP**TRACK

THE ULTRA-PORTABLE CAMERA SLIDER

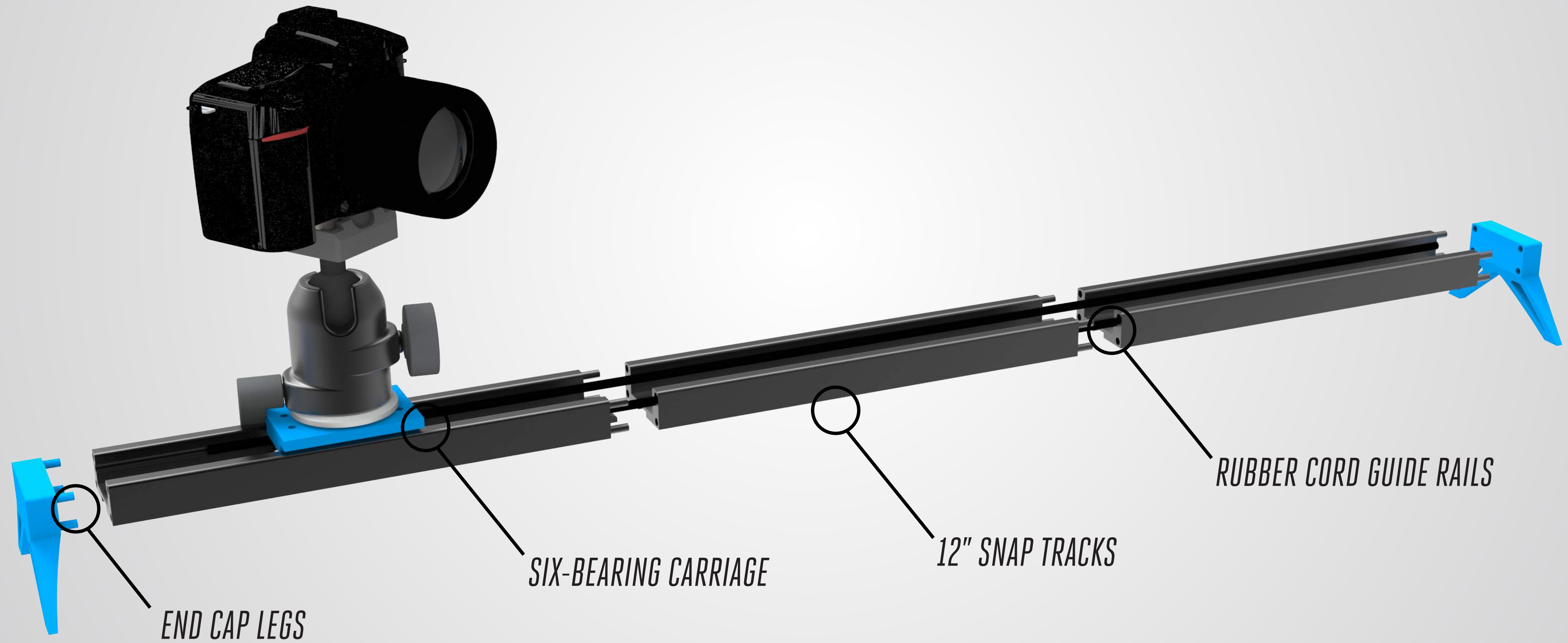

DESIGNED BY NIROSHAN AMARASIRIWARDENA & NATE APARO

*THE SOLUTION*

# *SNAP MECHANISM*

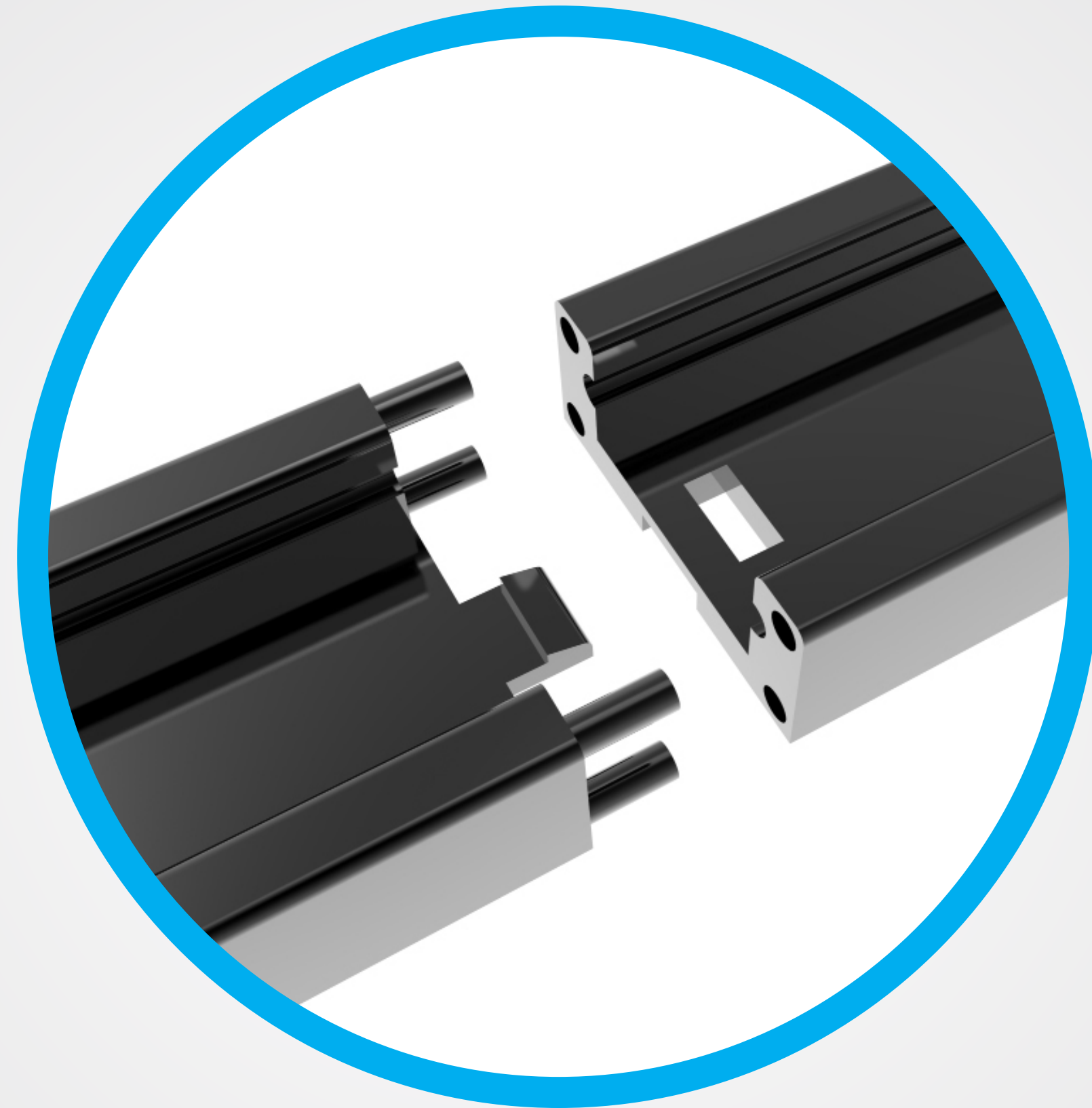

**Snap prevents pegs  
from pulling out linearly**

**Pegs counteract twisting  
and bending forces**



*THE SOLUTION*

*INNOVATION*

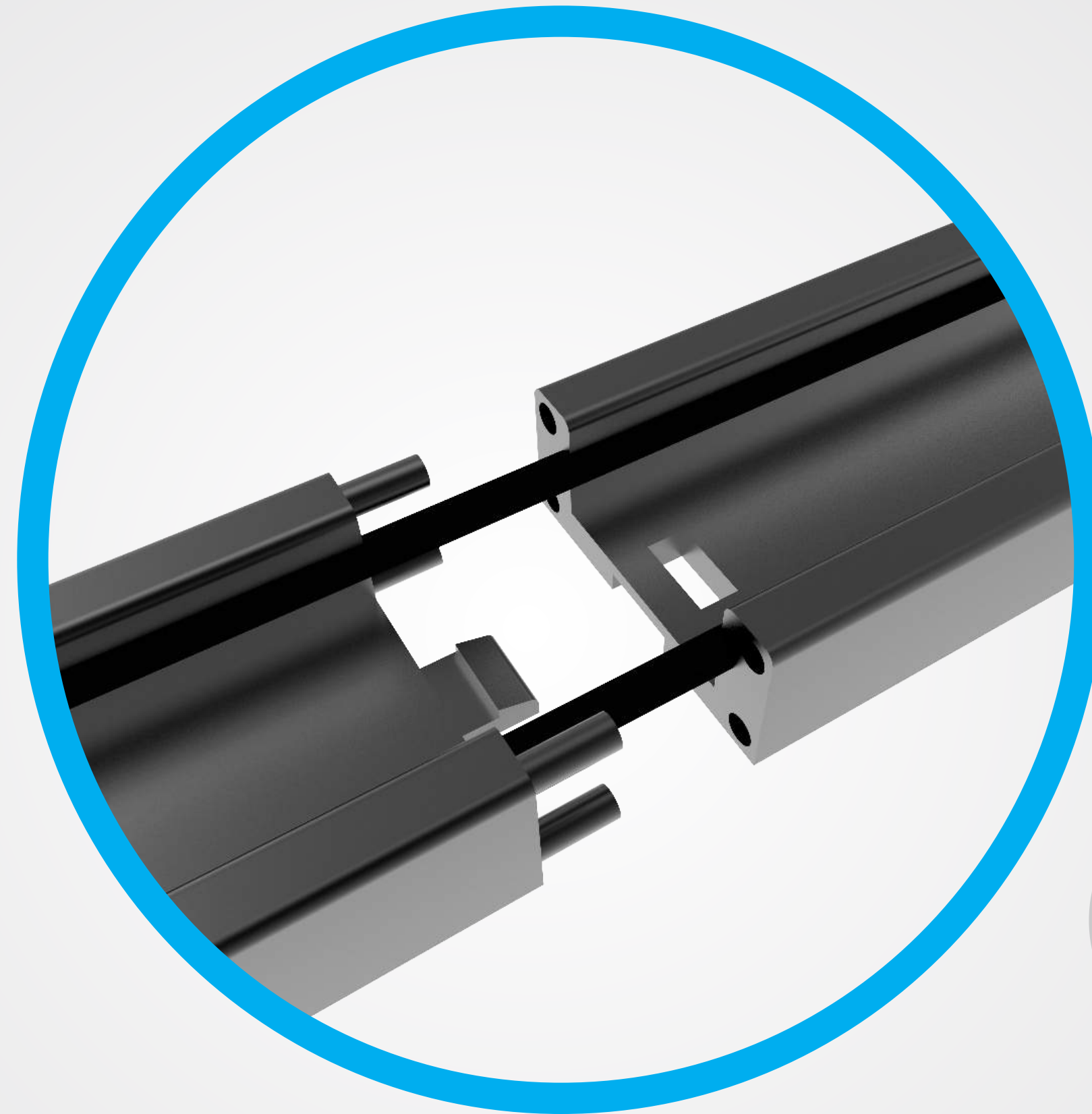

**Modular, but continuous track**

**Many applications**

**Patentable**

# THE SOLUTION

# SLIDER

- \$99 - aluminum
- \$69 - abs plastic
- 36" track
- roller-bearing
- six-bearing carriage
- carrying pouch

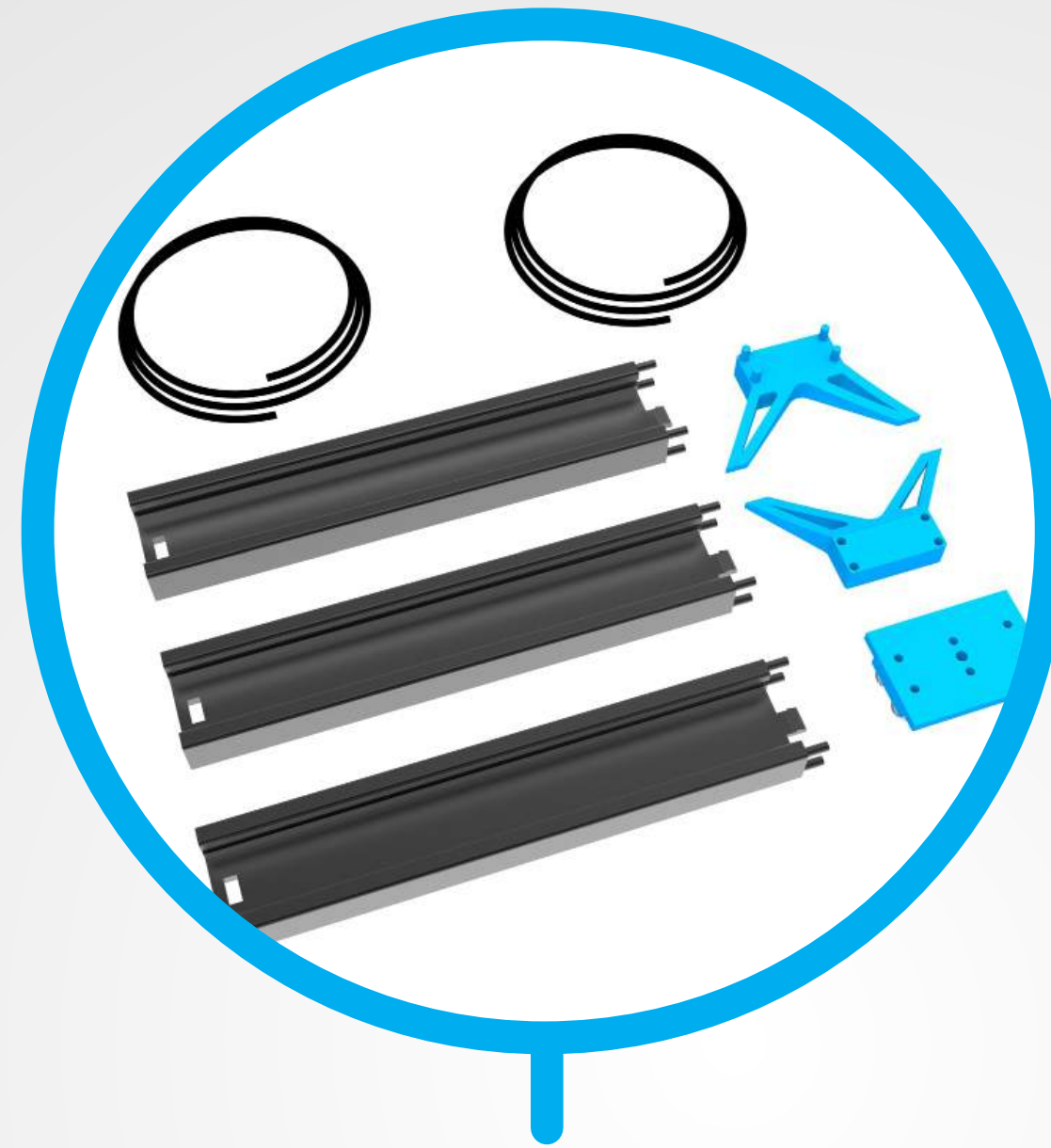

*DISASSEMBLED SLIDER*





## THE SOLUTION

- **\$179** - aluminum
- 36" track + accessories
- tripod
- fluid head mount
- tripod stores slider
- carrying case



## SLIDER+TRIPOD

TRIPOD STORES SLIDER

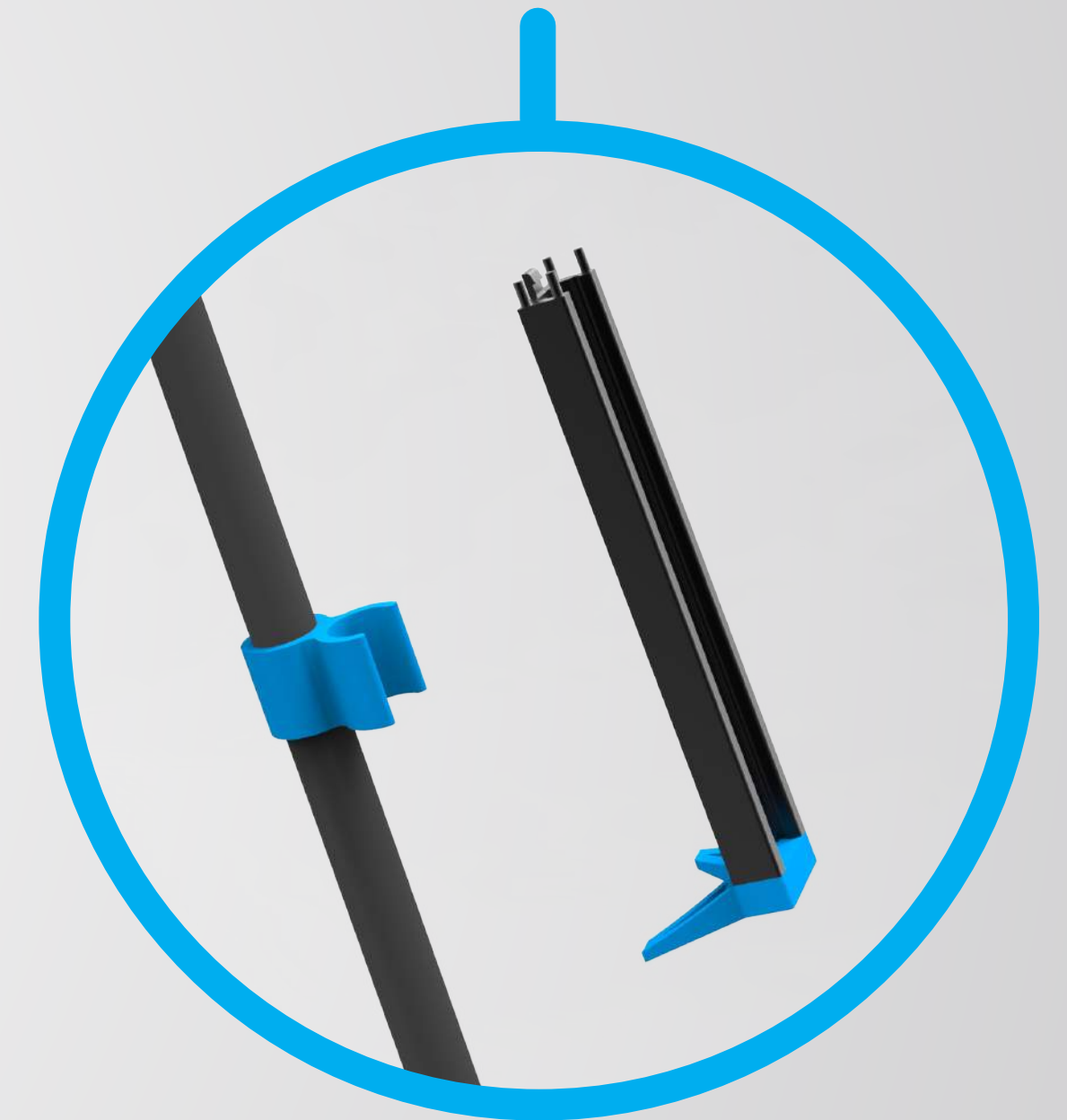

## **NEXT STEPS**

- Better bearings
- Experiment with cord thickness and durometer
- Prototype attachment mechanism
- Explore alternative attachment mechanisms



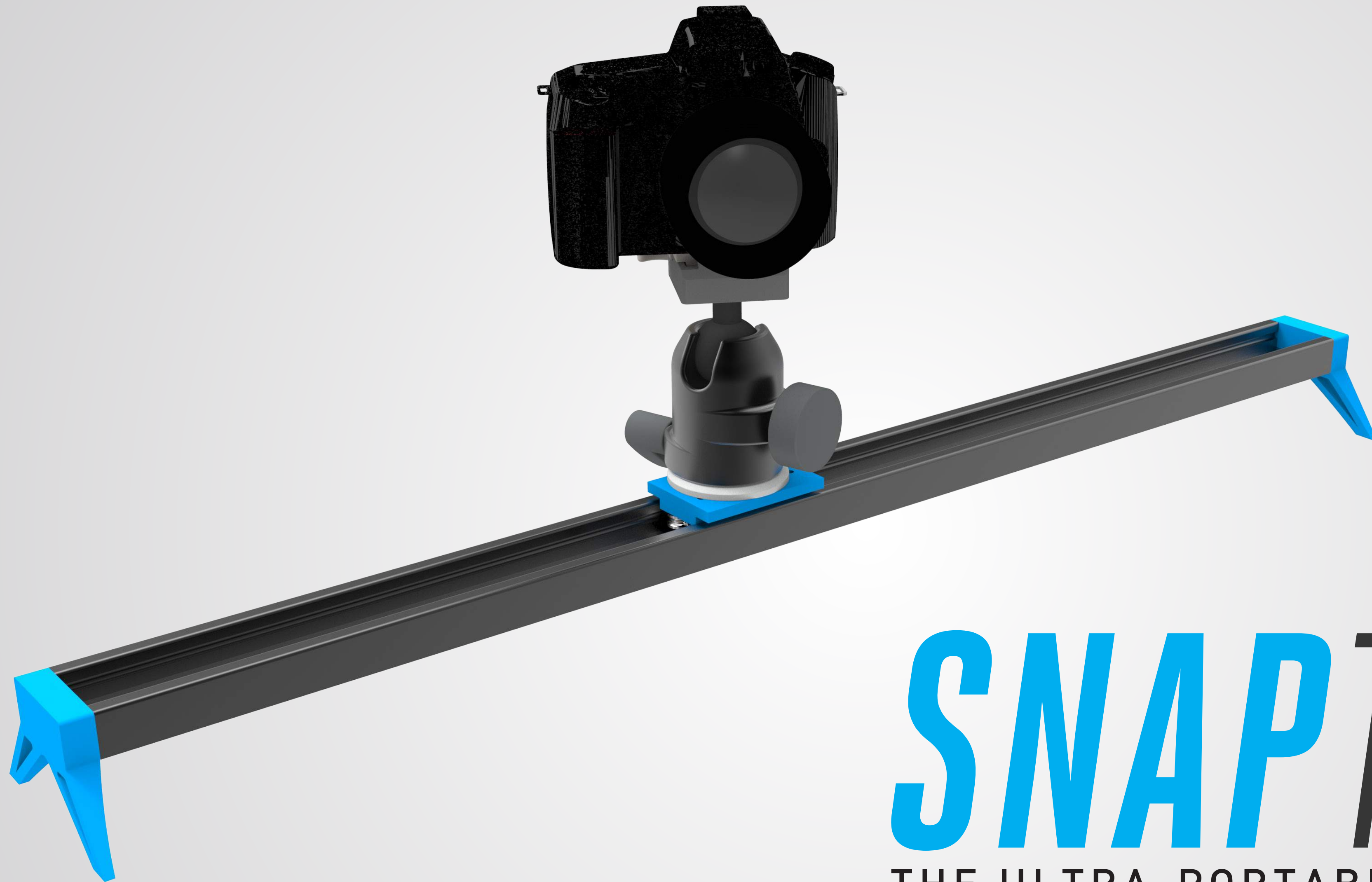

# **SNAP**TRACK

THE ULTRA-PORTABLE CAMERA SLIDER

DESIGNED BY NIROSHAN AMARASIRIWARDENA & NATE APARO